

Douro wijnproeverij

Voor het Broederschap van Wijnproevers - Oosterzele

Luc Wieme

28 oktober 2019

geschiedenis - highlights

- ▶ De geprivilegieerde relatie met Engeland
 - ▶ 1385 Windsor 1702 Methuen 2019 Brexit????

- ▶ De “eerste” oorsprongsafbakening (RDD) 1756

*Companhia geral da Agricultura
das Vinhas do Alto Douro*

door:



Sebastião
de Carvalho e Melo
MARKIES de POMBAL
1699-1782

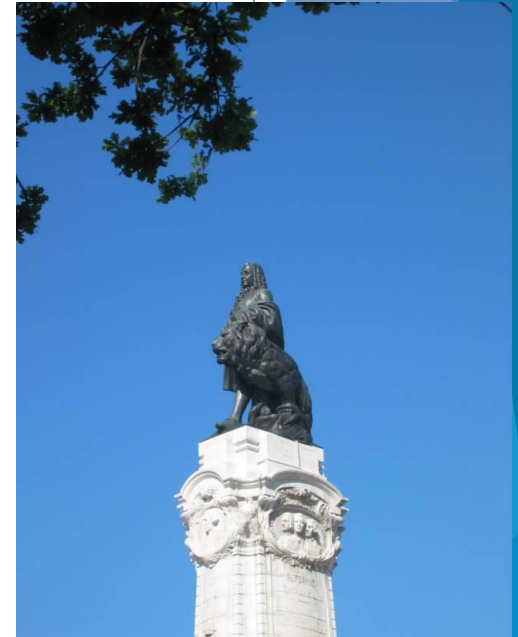

Modern times

- 1932 – 1974 Dictatorschap van Salazar
- 1986: Lidmaatschap EU
- 2001 Alto Douro= Unesco werelderfgoed



Norte
Centro
Lisboa e vale do Tejo
Alentejo
Algarve

... klimaatkennis



- ▶ Maritiem klimaat aan de Atlantische oceaan
- ▶ Continentaal klimaat landinwaarts
- ▶ Regenval:

Steden	Gemiddelde koudste maand	Gemiddelde warmste maand	Regenval
Porto	9°	20°	1150 mm
Lisboa	11°	22°	685 mm
Faro	12°	24°	450 mm
Barca d'Alva	7,5°	24°	650mm*
Bordeaux	5°	20°	900 mm
Lyon	2°	21°	813 mm
Brussel	1°	14°	800mm



Portugal, klein /groot wijnland

- ▶ Wereldproductie : op de 11de plaats **6,6 mio hl (2017)**
- ▶ op de 5de plaats in Europa (2015)

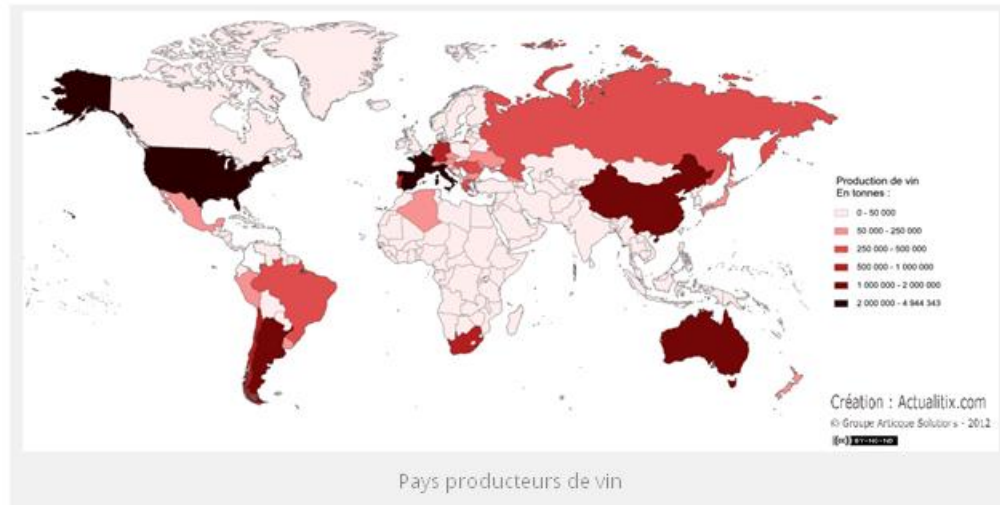

- ▶ Wijngaard opp.: 217 000 ha (2015)
- ▶ Consumptie: 41,8 l/jaar/inwoner (2013) : op de 4de plaats EU

Export evolutie 2010-15



	2010	2011	2012	2013	2014	2015	2016	2017	2018
NON FORTIFIED WINE	1.966.242	2.307.042	2.617.422	2.288.272	2.131.812	2.087.152	2.089.752	2.311.802	2.312.95
FORTIFIED WINE	700.206	771.562	768.293	734.953	720.772	712.674	687.881	681.347	652.811

in waarde (M €)

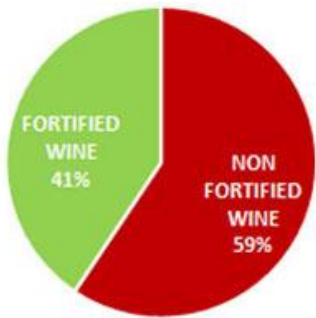

	2010	2011	2012	2013	2014	2015	2016	2017	2018
Série3	59%	41%							
— NON FORTIFIED WINE	318.600	331.621	379.285	386.594	396.207	401.325	393.445	448.028	477.309
— FORTIFIED WINE	295.780	325.297	328.173	333.301	332.557	336.000	330.225	331.584	326.025

Exportmarkten over 9 jaar (in M€)

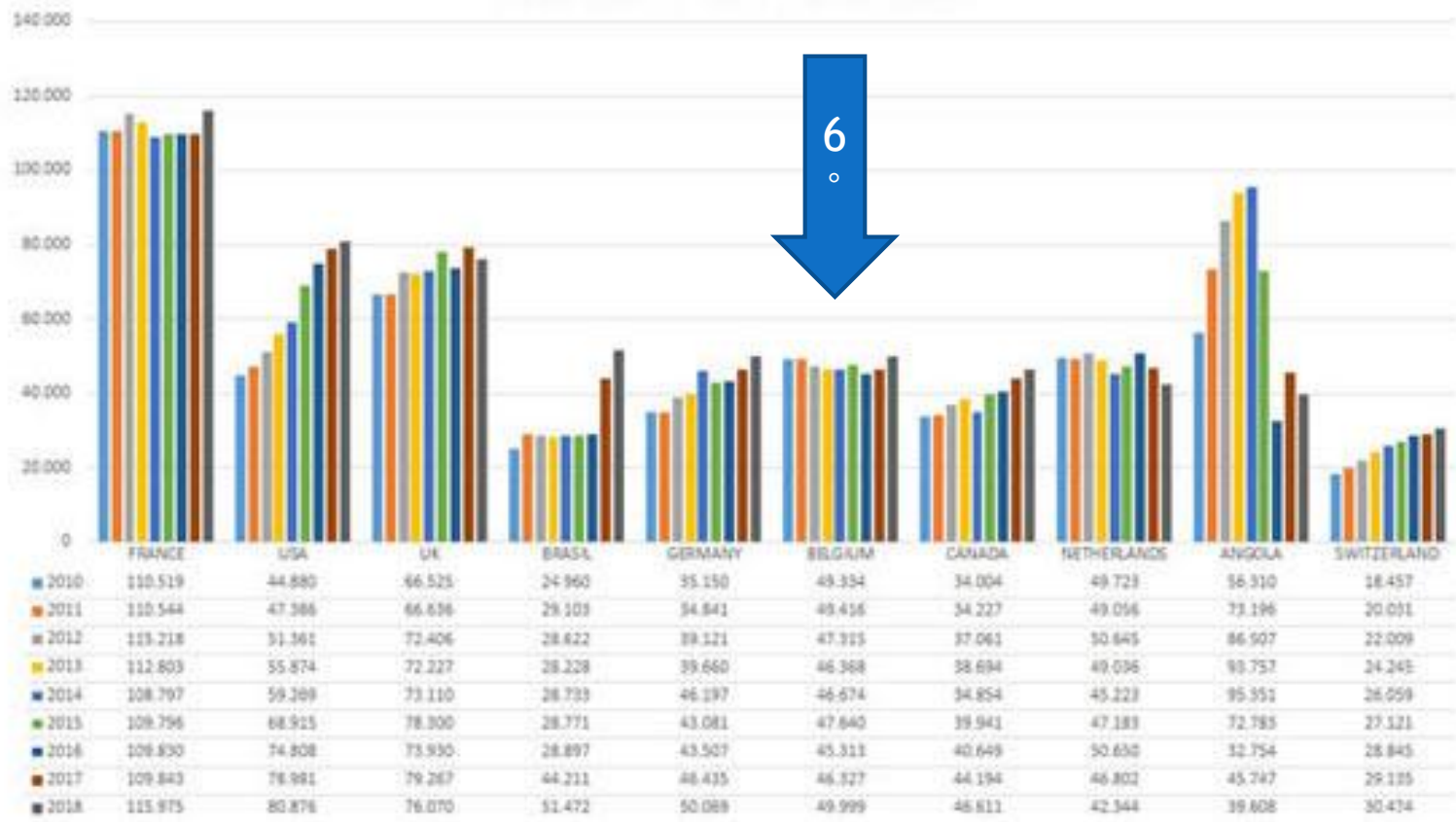

2010 -> 2018

Portugese wijnhiërarchie

Benamingen :

- Denominação de Origem Controlada (31 DOC of DOP)
- Vinho Regional (14 VR; IGP)
- Vinho (heel Portugal)

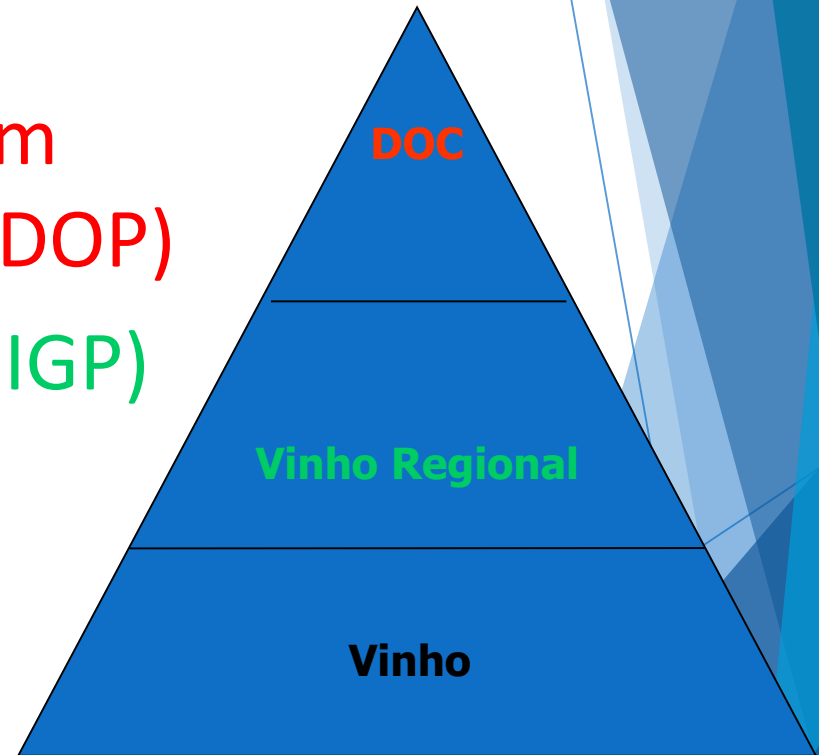

2014 PRODUCTIE

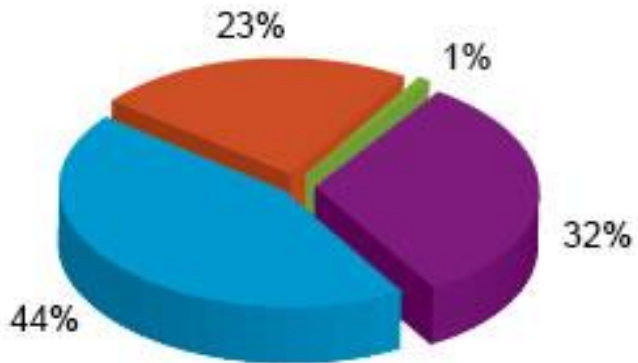

- DOP Wine
- Wine
- IGP Wine
- Wine with Year/Grape Variety



- Red/Rose
- White

Portugese wijnregio's

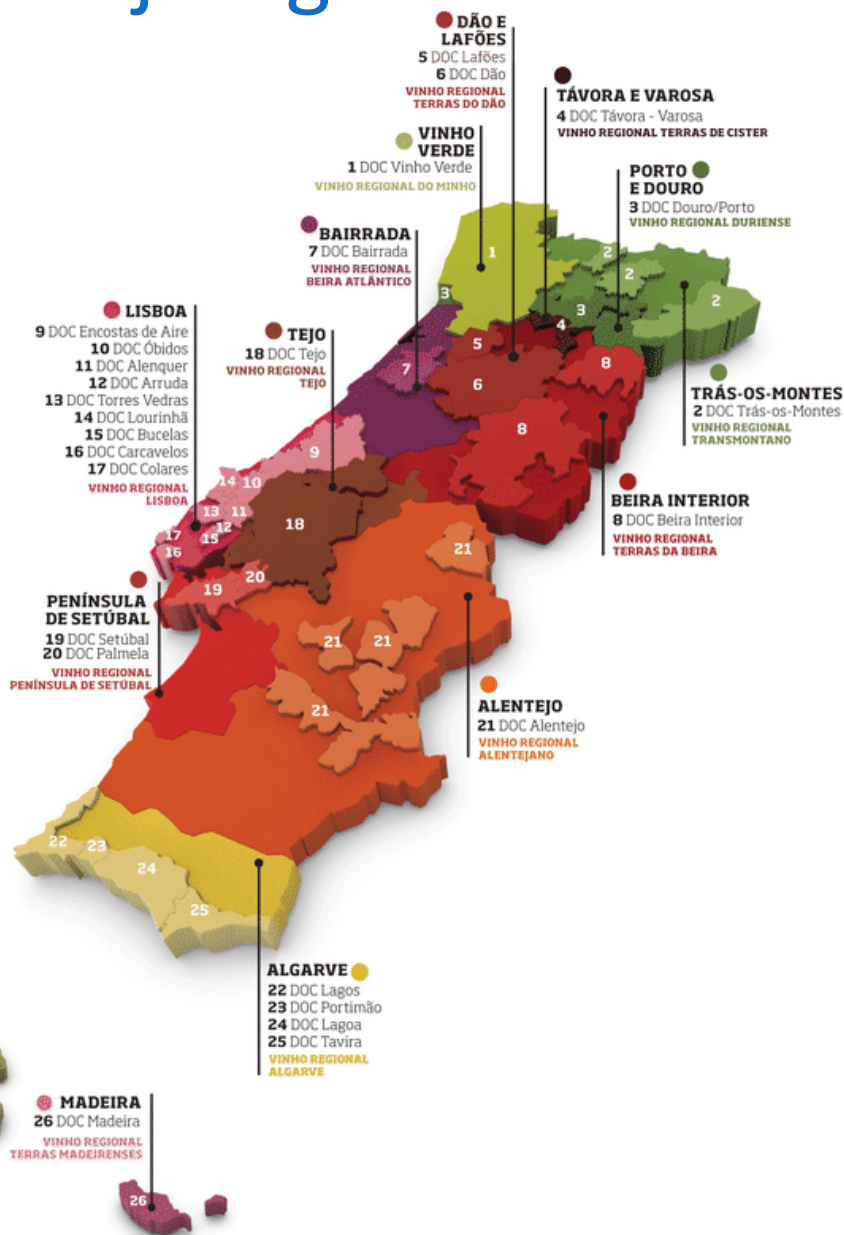

De grote regio's

Vinho Verde

Lisboa

Douro

Dao

Alentejo

Bairrada



Tejo

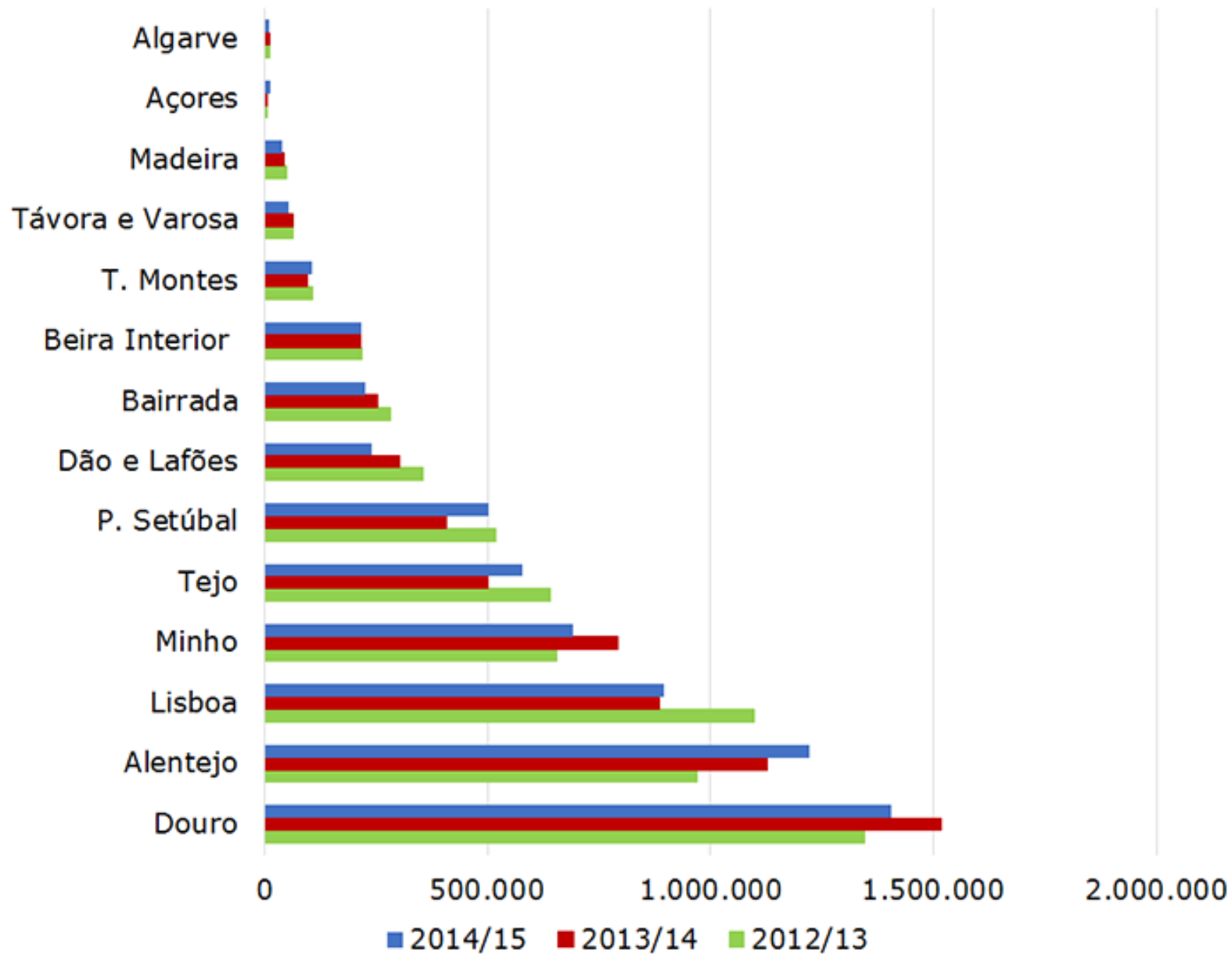

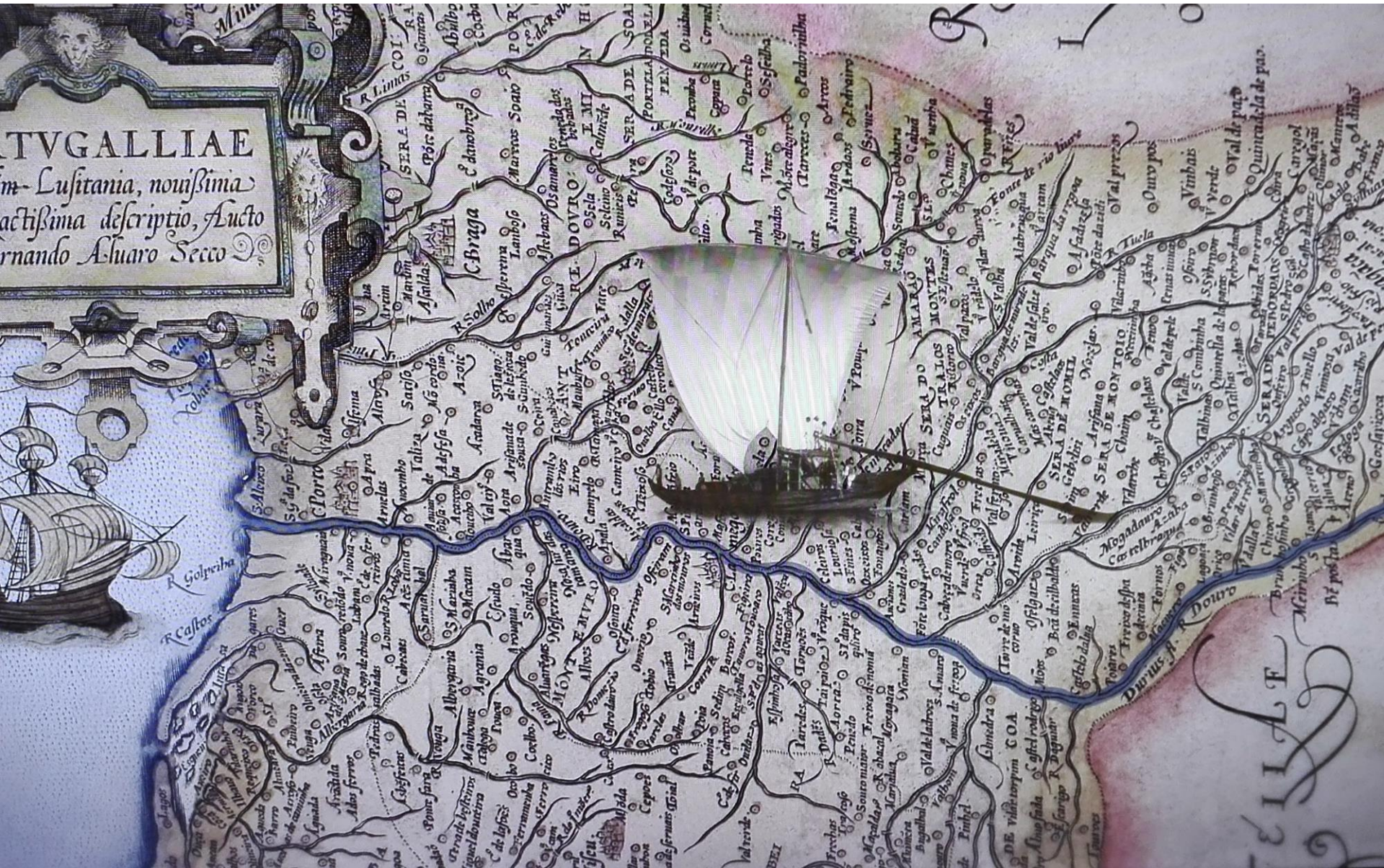

LUSITANIAE
Lusitania, nouissima
et exactissima descriptio, Auctore
Fernando Aluaro Secco

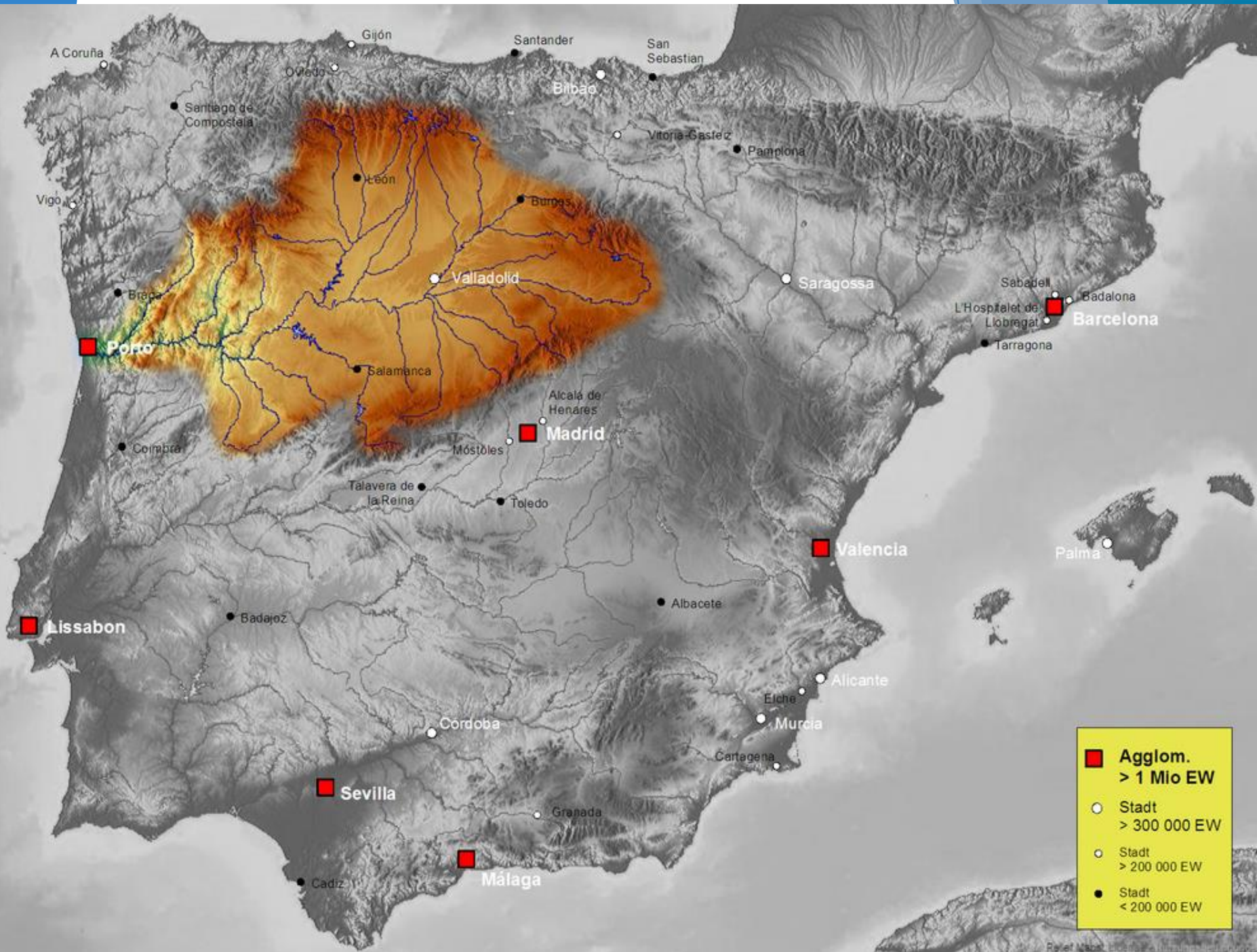

DOC Douro, de cijfers

- DO Douro & Porto : °1982
 - IVDP = regelgever
 - Totaal Douro areaal = 44 000ha in 2014
 - = goed voor gem. 140 000 000 liter alle categorieën

 - Baixo Corgo: 12000 ha (30%)
 - Cima Corgo: 18440 ha (47%)
 - Douro Superior:8900 ha (23%)
- 440 wijnmakers 280 bottelaars ; 33000 boeren!

En nog meer cijfers....

60% = Porto (2016 ; 80,5 mio l ; 2008 63,5%; 2014 50%)

32% = Douro (2016= 42,55 mio l; 2008 33 mio l = 24,5%; 2014 33%)

Verkoopcijfers 2018 : Porto 66% DO Douro 30%

4% = VR Duriense

4% = Moscatel en wat espumante Douro

Landschappen

Baixa Corgo : Peso da Regua



Landschappen

Cima Corgo : Quinta do Crasto



Landschappen

Cima Corgo : Pinhão





Landschappen

Douro Superior : Quinta das Marvalhas vineyards



Douro Superior : Barca d'Alva



Wijnbouw

Vóór phylloxera (1868) :



socalcos

Wijnbouw

Ná phylloxera

het landschap 'hertekend'



mortorios







LA ROSA

Vale do Inferno

recente wijnbouw

patamares







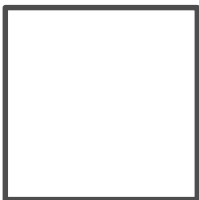

Vinhas ao alto











Bodem

- Meestal leisteen « **Schist** »
- > 1,5% organische materie in de bovenlaag
vertikaal of diagonaal gebroken
- In mindere mate : graniet







Meestal INHEEMSE, Portugese druiven..



11/19/2019

Rode druiven van de Douro

Touriga national

Touriga Franca

Tinta Roriz = Spaanse Tempranillo

Tinta Barroca

Tinta Cão en

Tinta Amarela (Sousão, Bastardo en Mourisco Tinto)

minimum 60%



VARGELLAS

De grote spelers

Sogrape

Sandeman
Ferreira
Offley

Fladgate

Taylor's
Kopke
Croft
Fonseca

Sogevinus

Càlem
Burmester
Barros
Kopke
Gilberts

Symington

Graham's
Dows
Cockburns
Warre's
Smith-Woodh
Qta de Roriz

Menu

**carta de
vinhos**

Vinhos verdes

Vinhos maduros

Wijngaarden voor Dourowijn

- ▶ (bijna) alle port producenten maken nu ook table wine
- ▶ lichte wijnen : in Baixo Corgo en in Douro superior
- ▶ Vinhas oa alto: quasi alleen voor niet versterkte wijn
- ▶ Port wijngaarden op de warmste plaatsen
- ▶ Douro superior is dé (enige) aanplantmogelijkheid

De mythische
Barca Velha
° 1952



Douro en de stad Porto

Vervoer wijn met Rabelos (boten)





SEAT

DOURO

VAU

3

12704

PORTO Cruz

PORTO Cruz

PORTO Cruz



TAYLOR'S

DELAFORCE
CROFT

OFFLEY

SANDEMAN

SANDEMAN

Vinificatie technieken

▶ Autovinificatie

▶ Pisar à pé

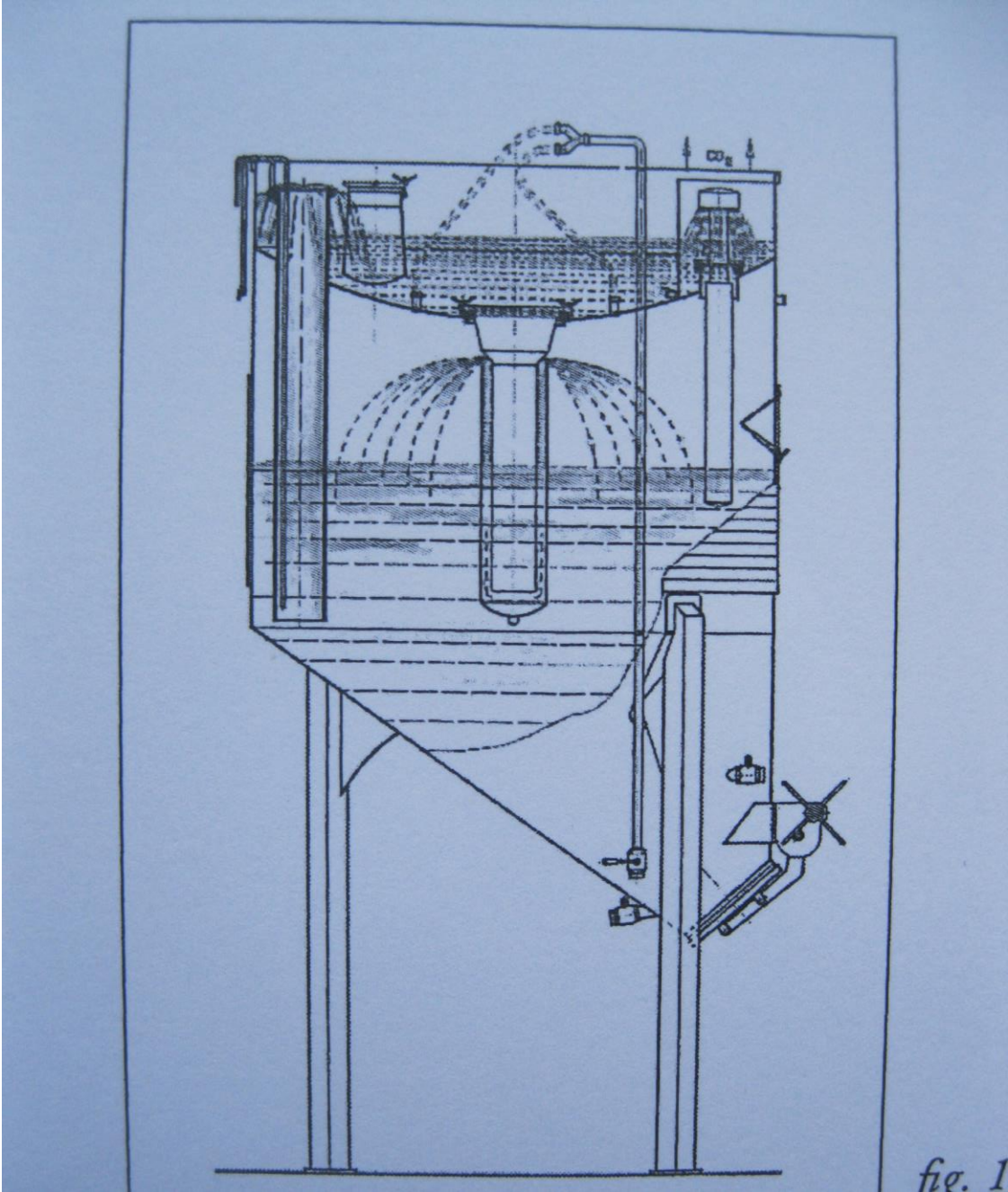

Kneuzen - Lagares



© 2006 Quinta do Noval









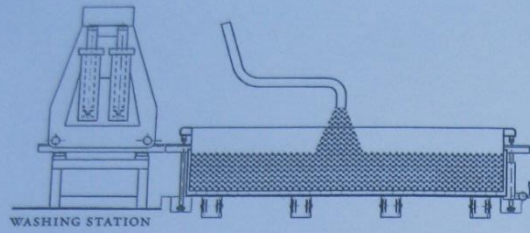

1. LAGAR THE FILLING

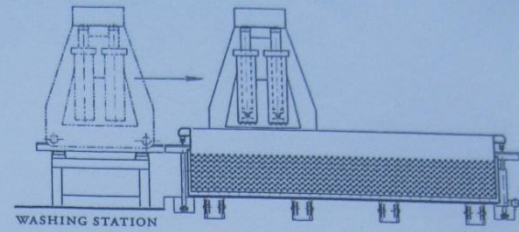

2. FEET MOVE INTO THE LAGAR

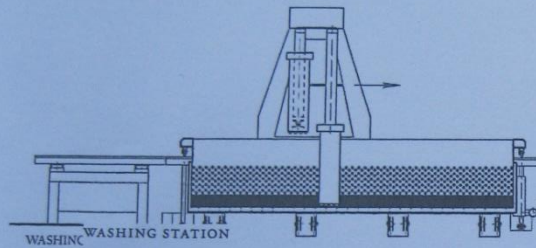

3. MECHANICAL FEET TREAD THE LAGAR

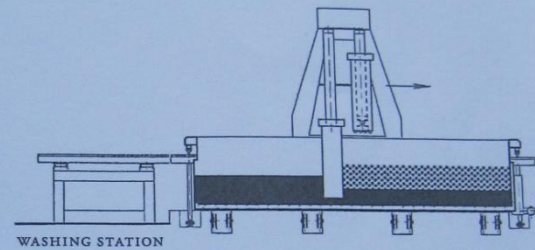

4. MECHANICAL FEET SUBMERGE THE CAP

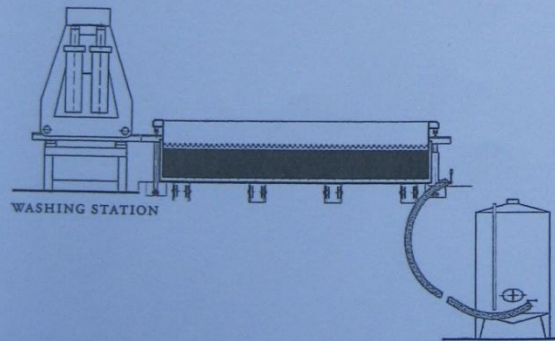

5. RUNNING OFF THE MUST

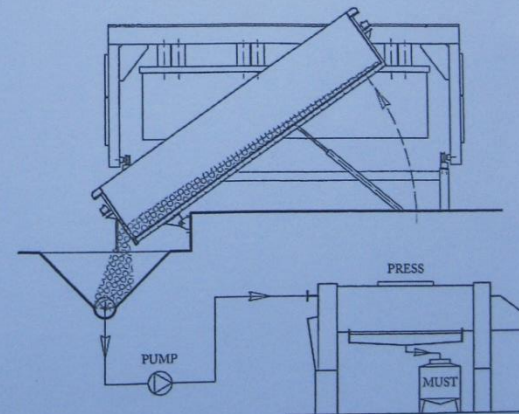

6. EMPTYING THE SKINS

fig. 2: The robotic lagar

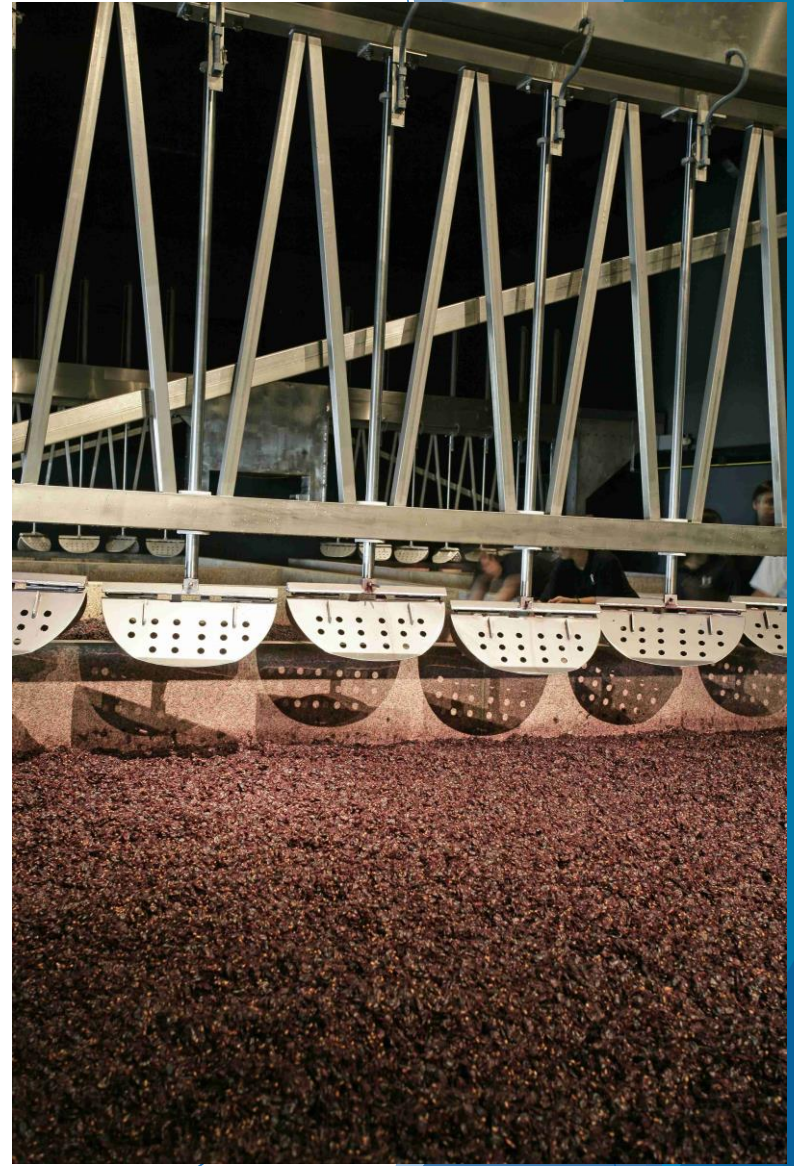

Douro boys



Quinta do Crasto
Quinta Vale Meão

Quinta do Vallado

Niepoort
Quinta Vale Dona Maria

DOURO Villa
120,00€

Vinho Tinto 2014

QUINTA DO VALE MEÃO
DOURO
DENOMINAÇÃO DE ORIGEM CONTROLADA
PRODUZIDO E ENGARRAFADO POR:
F. OLAZARBI & FILHOS, LDA V.N. DE FOZ COA
PRÓDUTO DE PORTUGAL

QUINTA DO VALE MEÃO
Vinho Tinto 2015

QUINTA DO VALE MEÃO
DOURO
DENOMINAÇÃO DE ORIGEM CONTROLADA
PRODUZIDO E ENGARRAFADO POR:
F. OLAZARBI & FILHOS, LDA
V.N. DE FOZ COA PORTUGAL
PRÓDUTO DE PORTUGAL

DOURO Villa
60,00€

QUINTA DO NOVATO
DOURO DOC
2012

Proeverij 28 okt 2019

1. Po de Poeira (Jorge Moreira)
1. Vertente van Niepoort
2. Pombal do Vesuvio
3. Quinta do Crasto superior
4. Quinta do Ataide 100% Touriga Nacional
5. **Post Scriptum 2017 Prats & Symington.**



Pò de Poeira 2017



- ▶ Wijnmaker: Jorge Moreira
- ▶ Eigen Quinta ligt in Provesende, Sabrosa (CC)
- ▶ 7,5 hectare oude wijnstokken en 1,5 hectare (2001°) jonge wijnstokken
1.5 ha with 10 years, 2,5 ha with 10 years and 3,5 with 7 years old vines
- ▶ Groot hoogteverschil (200 - 400m) lage en hoge percelen
-> 3 weken oogstverschil!
- ▶ Hij werkt bio(dynamisch). pizar à pé.
- ▶ Sousão, Touriga franca, Touriga nacional;
- ▶ Pò is hun 'tweede wijn', met vooral jonge stokken gemaakt.
- ▶ Wijn heeft 1 jaar houtlagering gehad, Frans maar niet nieuw. Malo op vat

Vertente 2016



- 1842- Franciscus Marius van der Niepoort
- DIRK Niepoort = vijfde generatie = een visionnair
- 1987 Maakt zijn eerste 'Redoma' in 1991; vanaf 2005 'solo'
- Gaat nu de biodynamische toer op

- Quinta do Nàpoles (200 à 400m ; 50à 80 jr oud – 10ha; 15ha jonge)
- in Santo Adrião, aan de Tedo (halfweg Regua-Pinhao)

- Maakt ook wijn in Bairrada, in Dao, maakt Vverde en zelfs riesling!





Een greep uit het gamma:

Redoma (reserva) Branco, Rosé , Tinto ;
Coche (°2010) (branco)
Tiara (branco)

Fabelhaft
Vertente BEE (°2015)
Charme
Turrís, Battuta, Bastardo, Tinta amarela
Robustus

Vertente 2016

- ▶ Meeste druiven van VV (>60jr) r, oever Douro (Pinhao), rest van ong.30 jaar oude stokken, l oever (Quinta do N) 150-500m
- ▶ Tinta Roriz, Touriga Franca e outras
- ▶ Oogst: half aug-eind sept; gisting in inox, vrij korte maceratie en extractie; maar malo in barrique Franse eik; ongeveer 20 maand rijping.
- ▶ Amper 12,5% alcohol.
- ▶ Botteling vd 2016: juni 2018
- ▶ *2016 gave us a cold and rainy Spring, which had an inevitable impact on the growth and development cycle of the vines. An extremely dry Summer ensued, with considerable fluctuations between day and night temperatures.*

Quinta do Crasto superior 2016



- ▶ In Cima Corgo, 135ha met 75ha wijngaard (° 1615)
- ▶ Al > eeuw eigendom van familie Almeida-Roquette
- ▶ Beroemd om zijn single quinta (vintage) ports.
- ▶ *“Prices vary, although the focus is on the premium and super premium products”*
- ▶ In 2002 joint venture met Jean-Michel Cazes v Lynch Bages -> Xisto ± 80€
- ▶ Superior red 2016: oogst vanaf 5 sept. Druiven uit Dsup Quinta da Cabreira
- ▶ Touriga Nacional, Touriga Franca, Tinta Roriz and Souzão; 15 jarige stokken
- ▶ Vinhas ao alto NO gericht en patamares, 130 à 450m hoogte
- ▶ Tri, ontristing, lichte kneuzing; vergisting in inox ; 1jr Franse eiken vaten
- ▶ Manuel Lobo oenoloog

Crasto gamma

- ▶ QUINTA DO CRASTO VINHA DA PONTE; QUINTA DO CRASTO VINHA MARIA TERESA;
- ▶ QUINTA DO CRASTO TINTA RORIZ; QUINTA DO CRASTO TOURIGA NACIONAL;
- ▶ QUINTA DO CRASTO RESERVA OLD VINES
- ▶ CRASTO SUPERIOR SYRAH, CRASTO SUPERIOR RED
CRASTO RED
- ▶ CRASTO SUPERIOR WHITE rosé, white,
- ▶ FLOR DE CRASTO WHITE / RED

Pombal do Vesuvio 2017

- ▶ Quinta do Vesuvio = de meest iconische quinta uit D superior, 45km v Spaanse grens, Z oever, 136ha op 325 ha, 7 heuvels en 31 valleien (tot 500m)
- ▶ Behoorde lang aan de Ferreira familie, sedert 1989 vd Symingtons.
- ▶ Symingtons : een verhaal apart!
- ▶ .

27 quinta's alleen al in de Douro!

8 wineries in de Douro

8 granieten lagares op Vesuvio
(13,500 liters elk = 24 pipas)

Basis 'tafelwijnen' = Altano

Quinta da Fonte Souto in Alentejo

Lid v "Primum Familiae Vini"



Pombal do Vesuvio 2017

- ▶ Quinta do Vesuvio = de meest iconische quinta uit D superior, 45km v Spaanse grens, Z oever, 136ha op 325 ha, 7 heuvels en 31 valleien (tot 500m)
- ▶ Behoorde lang aan de Ferreira familie, sedert 1989 vd Symingtons.
- ▶ Symingtons : een verhaal apart!
- ▶ Charles Symington en Pedro Correia = oenologen
- ▶ 50% touriga nacional, 45% touriga franca en 5% tinta amarela.
- ▶ Pombal is de tweede wijn, de eerste heet gewoon 'Quinta do Vesuvio' (id,x3) handgeplukt in bakjes van 20 kg. Manuele tri bij aankomst, zachte ontristing, machinale tri van de bessen, geen pompen voor het overbrengen naar de cuves, waar de nog hele druiven zacht en gedeeltelijk worden gekneusd. Gisting met pigeages, remontages en délestages, afhankelijk van de cuvée. Post-fermentaire maceratie en dan 10 maand in Franse vaten. >3000 kisten van 12fl en 300 magnums.

Post Scriptum 2017 Douro. Prats & Symington

- P + S = ? °1999
- 1° PS : °2002
- Castas:
- 2009 : TNacional 41% T Franca 36% TRoriz 14% TBarroca 9%
- 2015 : TNacional 53% T Franca 47%
- 2016 : TNacional 68% T Franca 32%
- 2017 : TNacional 49% T Franca 51%
- Vinhas: *Quinta da Perdiz* en *Quinta Roriz* (niet meer Bomfin en Vesuvio)
- Druiven ontrist en zacht gekneusd Fermentatie in kleine cuves inox à slechts 25° ; lange maar zachte maceratie tijdens de gisting
- Vaten v 400 liter “neutrale” Franse eik 1 jaar
- 2017 was een uitzonderlijk vroeg oogstjaar .
- 14° alc 6000 kisten v 12 fl
- Top wijn : de Chryseia



Terrassen/s van Quinta da Perdiz



THE TOP 10 WINES OF 2014

#3

Prats &
Symington

Douro Chryseia 2011

97
SCORE

2,400
CASES MADE





CHRYSEIA

Quinta do Ataíde

Vinha do Arco TN 2015

- ▶ Ook van de Symingtons, sorry ...
- ▶ Gekocht in 2010, 18^e eeuwse manoir, 13,5ha wijngaard op 100ha
- ▶ Vilarica Valley heeft een uniek terroir : schist én leem
- ▶ Hier zorgde Miguel Corte Real voor de hergeboorte vd TN
- ▶ Organische wijnbouw, wild gras tssn de rijen
- ▶ Slechts 2 wijnen: de Ataíde (blend)
- ▶ en de Vinha do Arco, 100 %TN ;
- ▶ Charles Symington e Pedro Correia
- ▶ fermentatie en malo in inox; 10-12 maand in Franse eiken vaten v 400 liter

lank voor uw aandacht



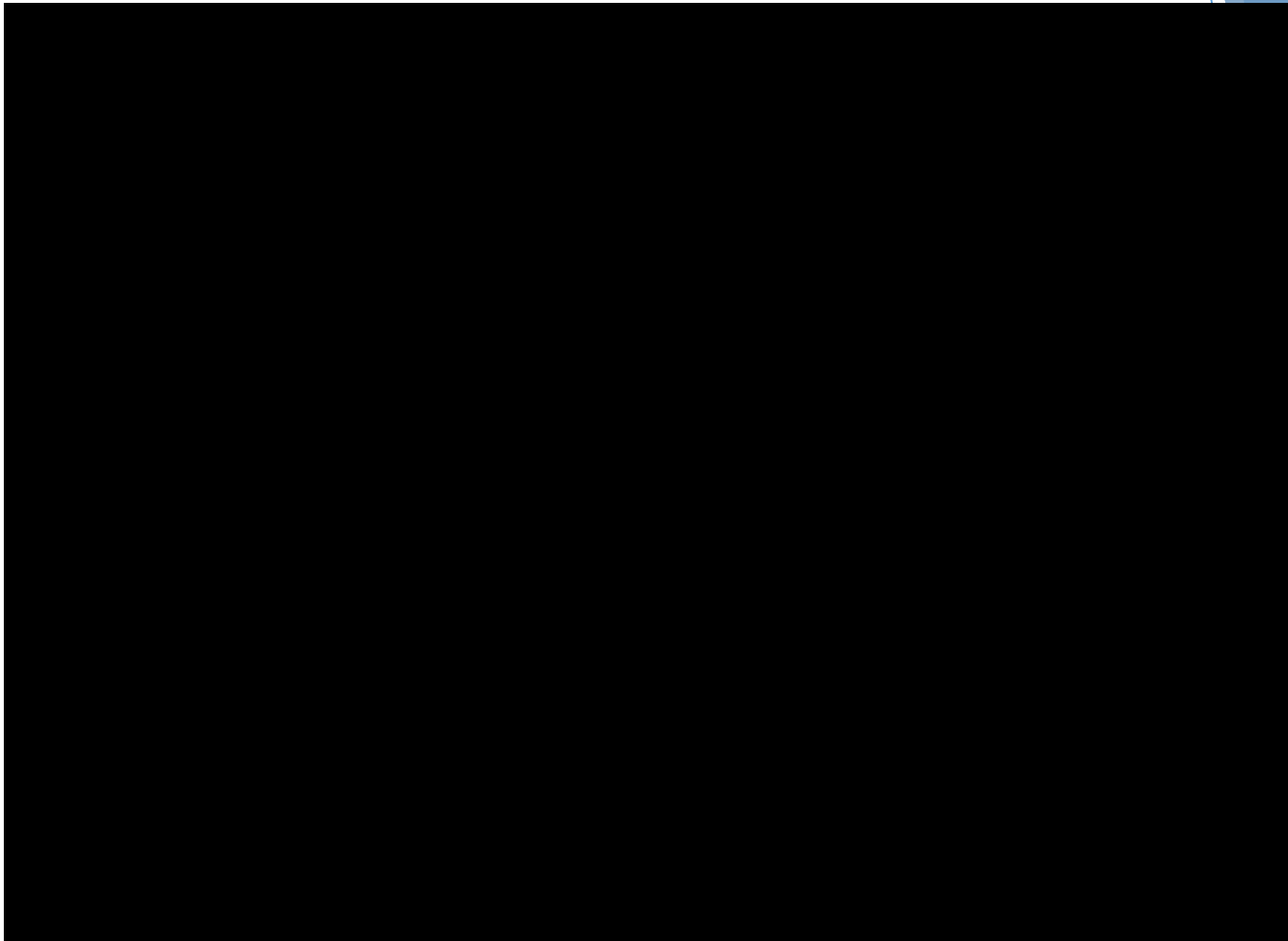

Quinta do Portal Reserva 2016

Oud familiedomein, in beginjaren 90 gemoderniseerd tot Boutique winery

Op hoge hoogte gelegen in Sabrosa ; oenotoerisme

100 ha ; Porto Douro Moscatel Azeite, Espumante en Vinho verde

De Reserva 2016 is 45% TN 40TRoriz en 15% T franca

Alc 14,5 5 ton/ha; 20 000 fl en 120 magnums

Manuele pluk, tussen 29 sept en 14 oktober

Gisting in inox op 24-26°, 9 mnd in oude en nieuwe franse vaten

Paulo Coutinho oenoloog